

SPICE thermal model

BUK653R7-30C

Symbol	Parameter	Conditions	Min	Typ	Max	Unit
$R_{th(j-mb)}$	thermal resistance from junction to mounting base		-	-	0.95	K/W

C_{th1}	4.700E-02 F
C_{th2}	7.316E-03 F
C_{th3}	1.695E-03 F
C_{th4}	3.926E-04 F
C_{th5}	9.096E-05 F
C_{th6}	2.107E-05 F
C_{th7}	4.881E-06 F
C_{th8}	1.131E-06 F
R_{th1}	6.330E-01 Ω
R_{th2}	2.380E-01 Ω
R_{th3}	5.900E-02 Ω
R_{th4}	1.500E-02 Ω
R_{th5}	3.725E-03 Ω
R_{th6}	9.321E-04 Ω
R_{th7}	2.332E-04 Ω
R_{th8}	5.836E-05 Ω

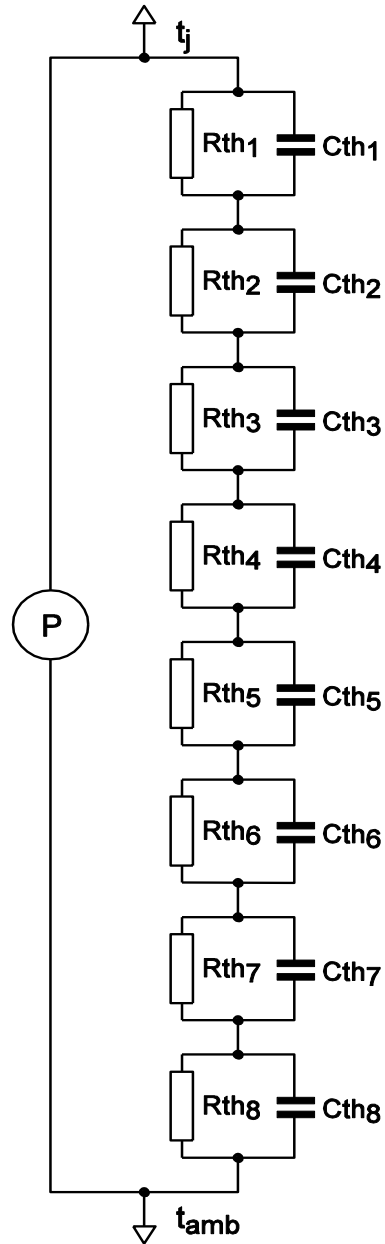

001aal768

Part: BUK653R7-30C
 Version: 1
 Date: 7-7-2010
 Rth: 0.952062434